



# Oras

Installation and maintenance guide





4-16



17-19



20-21

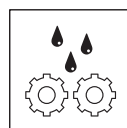

22-26



27



## 7460, 7460-107, 7460C, 7460K-106

I (ISO 3822) Oras lab.

EN 1111

100 - 1000 kPa

**7460, 7460C:**

0.19 l/s (Eco)

0.27 l/s (300 kPa)

165 kPa (0.2 l/s)

**7460-107:**

0.13 l/s (300 kPa w/Controller)

**7460K-106:**

0.10 l/s (300 kPa w/Controller)

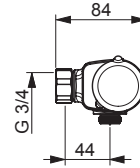
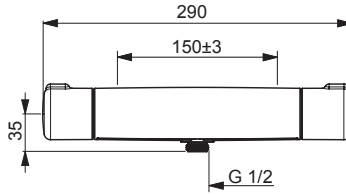

[mpi.oras.com/7460](http://mpi.oras.com/7460)

max. +80°C

## 7460-33, 7460C-33

I (ISO 3822) Oras lab.

EN 1111

100 - 1000 kPa

0.19 l/s (Eco)

0.27 l/s (300 kPa)

165 kPa (0.2 l/s)

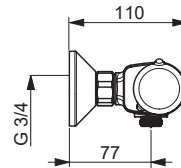
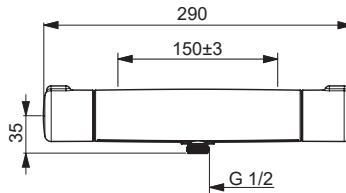

[mpi.oras.com/7460-33](http://mpi.oras.com/7460-33)

max. +80°C

## 7460GL

I (ISO 3822) Oras lab.

EN 1111

100 - 1000 kPa

0.10 l/s (Eco)

0.20 l/s (300 kPa)

300 kPa (0.2 l/s)

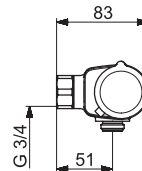
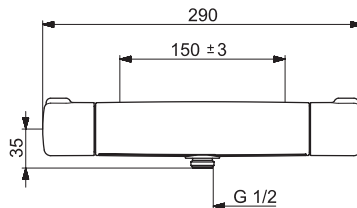

[mpi.oras.com/7460GL](http://mpi.oras.com/7460GL)

max. +80°C





## 7460U, 7460U-33

I (ISO 3822) Oras lab.  
EN 1111  
100 - 1000 kPa  
0.19 l/s (Eco)  
0.27 l/s (300 kPa)  
165 kPa (0.2 l/s)

max. +80°C

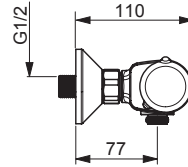
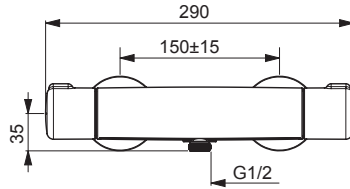

[mpi.oras.com/7460U](http://mpi.oras.com/7460U)

## 7460X

I (ISO 3822) Oras lab.  
EN 1111  
100 - 1000 kPa  
0.19 l/s (Eco)  
165 kPa (0.2 l/s)

max. +80°C

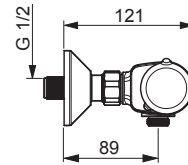
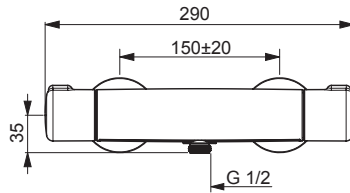

[mpi.oras.com/7460X](http://mpi.oras.com/7460X)

## 7461

I (ISO 3822) Oras lab.  
EN 1111  
100 - 1000 kPa  
0.19 l/s (Eco)  
0.28 l/s (300 kPa)  
165 kPa (0.2 l/s)

max. +80°C

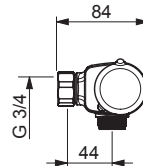
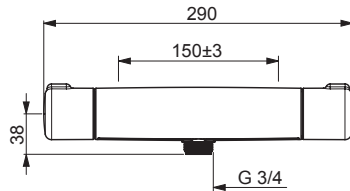

[mpi.oras.com/7461](http://mpi.oras.com/7461)



## 7462, 7462G, 7462L

I (ISO 3822)

EN 1111

100 - 1000 kPa

**7462, 7462L:**

0.16 l/s (Eco)

0.33 l/s (300 kPa)

230 kPa (0.2 l/s)

300 kPa (0.3 l/s)

**7462G:**

0.23 l/s (300 kPa)

230 kPa (0.2 l/s)

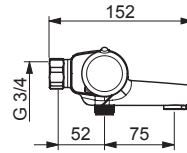
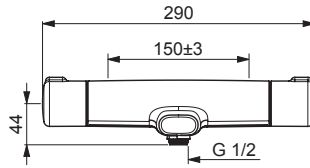

[mpi.oras.com/7462](http://mpi.oras.com/7462)

max. +80°C

## 7462G-33

I (ISO 3822)

EN 1111

100 - 1000 kPa

0.16 l/s (Eco)

0.23 l/s (300 kPa)

230 kPa (0.2 l/s)

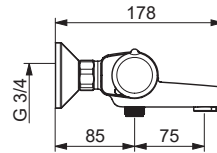
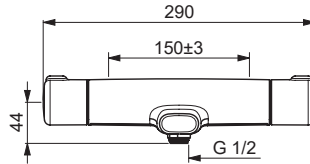

[mpi.oras.com/7462G-33](http://mpi.oras.com/7462G-33)

max. +80°C

## 7462U, 7462U-33

I (ISO 3822) Oras lab.

EN 1111

100 - 1000 kPa

0.16 l/s (Eco)

0.33 l/s (300 kPa)

230 kPa (0.2 l/s)

300 kPa (0.3 l/s)

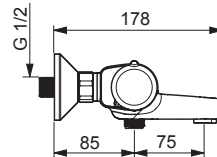
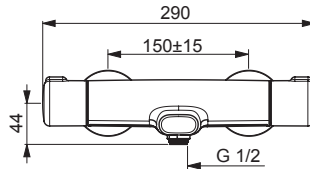

[mpi.oras.com/7462U](http://mpi.oras.com/7462U)

max. +80°C

## 7464, 7464-33

I (ISO 3822) Oras lab.  
EN 1111  
100 - 1000 kPa  
0.19 l/s (Eco)  
0.27 l/s (300 kPa)  
165 kPa (0.2 l/s)

max. +80°C

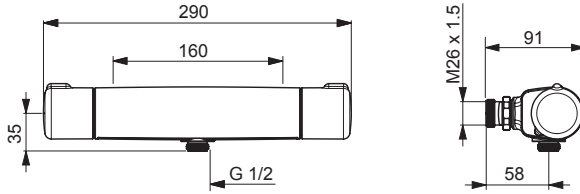

[mpi.oras.com/7464](http://mpi.oras.com/7464)

## 7464GL

I (ISO 3822) Oras lab.  
EN 1111  
100 - 1000 kPa  
0.10 l/s (Eco)  
165 kPa (0.2 l/s)

max. +80°C

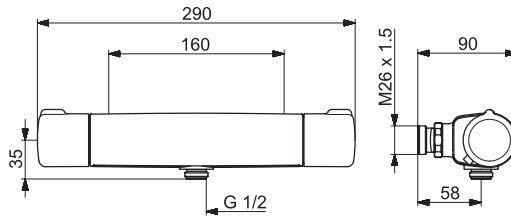

[mpi.oras.com/7464GL](http://mpi.oras.com/7464GL)

## 7466

I (ISO 3822) Oras lab.  
EN 1111  
100 - 1000 kPa  
0.18 l/s (Eco)  
0.26 l/s (300 kPa)  
180 kPa (0.2 l/s)

max. +80°C

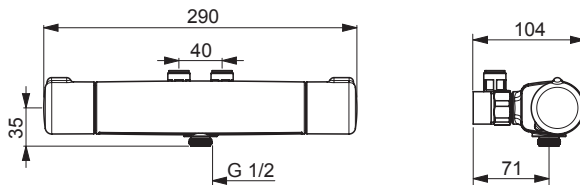

[mpi.oras.com/7466](http://mpi.oras.com/7466)



## 7469

EN 1111  
 100 - 1000 kPa  
 0.27 l/s (300 kPa)  
 165 kPa (0.2 l/s)

max. +80°C

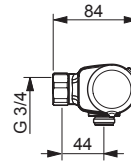
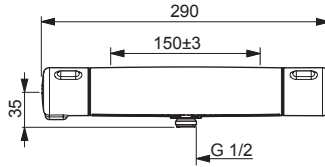

[mpi.oras.com/7469](http://mpi.oras.com/7469)

## 7470X

I (ISO 3822) Oras lab.  
 EN 1111  
 100 - 1000 kPa  
 0.19 l/s (Eco)  
 0.27 l/s (300 kPa)  
 165 kPa (0.2 l/s)

max. +80°C

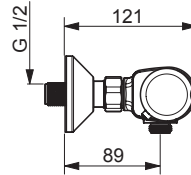
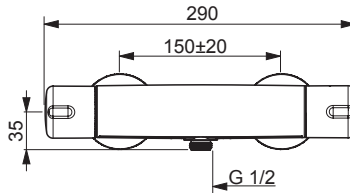

[mpi.oras.com/7470X](http://mpi.oras.com/7470X)

## 7470U

I (ISO 3822) Oras lab.  
 EN 1111  
 100 - 1000 kPa  
 0.19 l/s (Eco)  
 0.27 l/s (300 kPa)  
 165 kPa (0.2 l/s)

max. +80°C

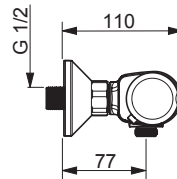
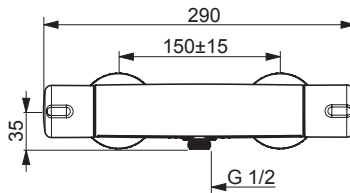

[mpi.oras.com/7470U](http://mpi.oras.com/7470U)

## 7471

I (ISO 3822) Oras lab.  
EN 1111  
100 - 1000 kPa  
0.19 l/s (Eco)  
0.27 l/s (300 kPa)  
165 kPa (0.2 l/s)

max. +80°C

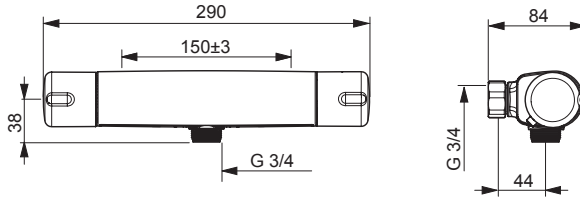

[mpi.oras.com/7471](https://mpi.oras.com/7471)

## 7420

I (ISO 3822) Oras lab.  
EN 1111  
100 - 1000 kPa  
0.15 l/s (300 kPa w/Controller)  
150 kPa (0.2 l/s)

max. +80°C

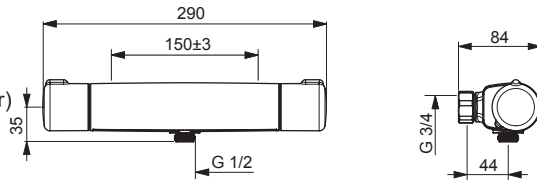

[mpi.oras.com/7420](https://mpi.oras.com/7420)

## 7442U

I (ISO 3822) Oras lab.  
EN 1111  
100 - 1000 kPa  
0.18 l/s (Eco)  
0.30 l/s (300 kPa)  
180 kPa (0.2 l/s)  
300 kPa (0.3 l/s)

max. +80°C

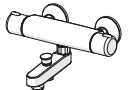
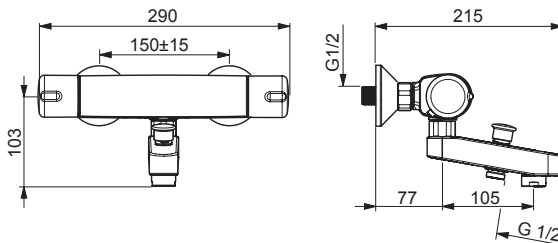

[mpi.oras.com/7442U](https://mpi.oras.com/7442U)



## 7443, 7443-33, 7443L

II (ISO 3822) Oras lab.

EN 1111

100 - 1000 kPa

0.16 l/s (Eco)

0.33 l/s (300 kPa)

230 kPa (0.2 l/s)

300 kPa (0.3 l/s)

max. +80°C

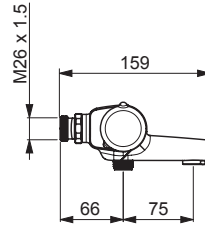
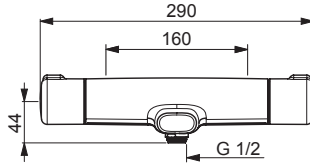

[mpi.oras.com/7443](http://mpi.oras.com/7443)

## 7445

II (ISO 3822) Oras lab.

EN 1111

100 - 1000 kPa

0.15 l/s (Eco)

0.3 l/s (300 kPa)

250 kPa (0.2 l/s)

300 kPa (0.3 l/s)

max. +80°C

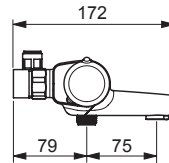
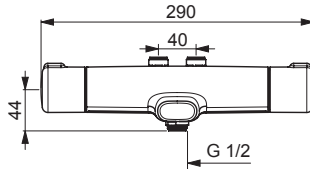

[mpi.oras.com/7445](http://mpi.oras.com/7445)

## 7446X

I (ISO 3822) Oras lab.

EN 1111

100 - 1000 kPa

0.16 l/s (Eco)

0.23 l/s (300 kPa)

230 kPa (0.2 l/s)

max. +80°C

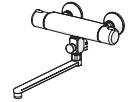
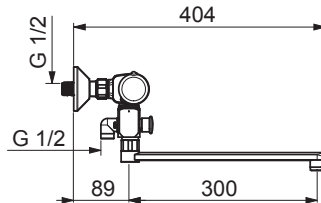
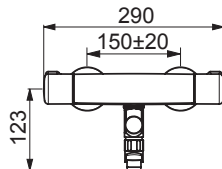

[mpi.oras.com/7446X](http://mpi.oras.com/7446X)

## 7447X

I (ISO 3822) Oras lab.  
 EN 1111  
 100 - 1000 kPa  
 0.16 l/s (Eco)  
 0.23 l/s (300 kPa)  
 230 kPa (0.2 l/s)

max. +80°C

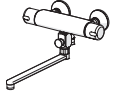
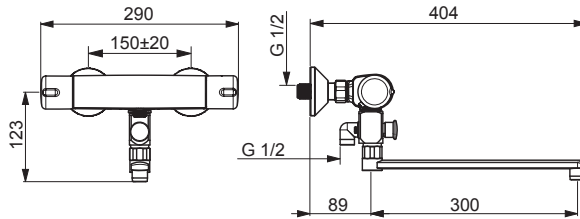

[mpi.oras.com/7447X](http://mpi.oras.com/7447X)

## 7484

I (ISO 3822) Oras lab.  
 EN 1111, EN 1113  
 100 - 1000 kPa  
 0.18 l/s (Eco)  
 0.26 l/s (300 kPa)  
 180 kPa (0.2 l/s)

max. +65°C

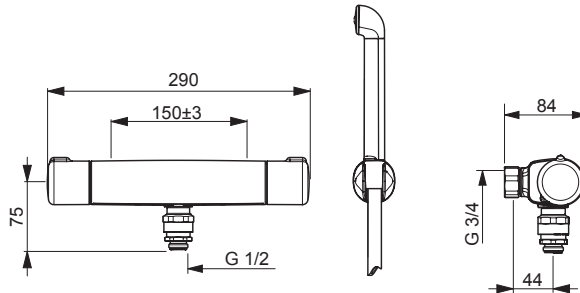

[mpi.oras.com/7484](http://mpi.oras.com/7484)

## 7412 (7460+530), 7412G, 7412G-33, 7412GL

I (ISO 3822) Oras lab.  
 EN 1111, EN 1112, EN 1113  
 100 - 1000 kPa

**7412:**

0.12 l/s (300 kPa w/Controller)  
 200 kPa (0.2 l/s)

**7412G:, 7412G-33, 7412GL:**

0.12 l/s (Eco)  
 200 kPa (0.2 l/s)

max. +65°C

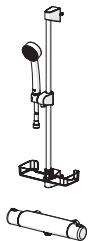
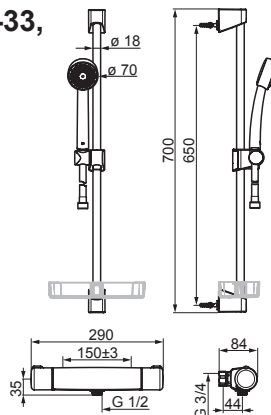

[mpi.oras.com/7412](http://mpi.oras.com/7412)



## 7413 (7460+544)

I (ISO 3822) Oras lab.  
 EN 1111, EN 1112, EN 1113  
 100 - 1000 kPa  
 0.16 l/s (Eco)  
 0.24 l/s (300 kPa)  
 210 kPa (0.2 l/s)

max. +65°C

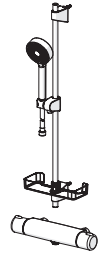
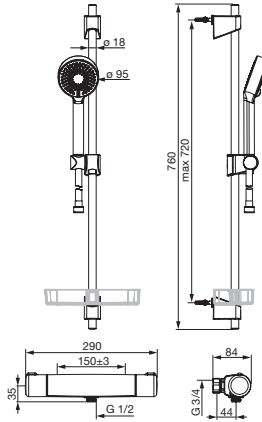

mpi.oras.com/7413

## 7413U (7460U+544)

I (ISO 3822) Oras lab.  
 EN 1111, EN 1112, EN 1113  
 100 - 1000 kPa  
 0.16 l/s (Eco)  
 0.24 l/s (300 kPa)  
 210 kPa (0.2 l/s)

max. +65°C

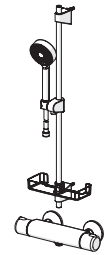
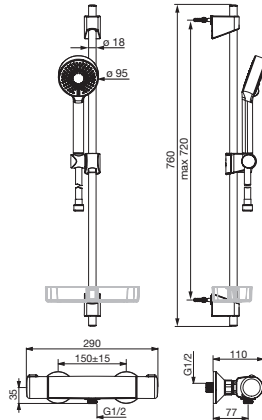

mpi.oras.com/7413U

## 7414U (7462U+544)

I (ISO 3822) Oras lab.  
 EN 1111, EN 1112, EN 1113  
 100 - 1000 kPa  
 0.14 l/s (Eco)  
 0.33 l/s (300 kPa)  
 300 kPa (0.3 l/s)

max. +65°C

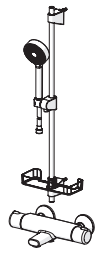
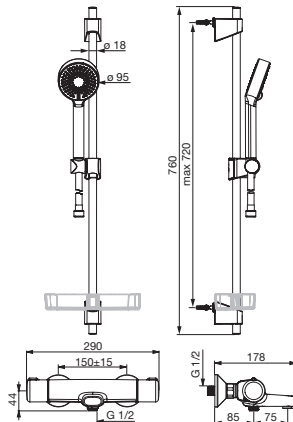

mpi.oras.com/7414U



## 7422 (7464+530), 7422G, 7422G-33, 7422GL

I (ISO 3822) Oras lab.  
EN 1111, EN 1112, EN 1113  
100 - 1000 kPa

### 7412:

0.12 l/s (300 kPa w/Controller)  
200 kPa (0.2 l/s)

### 7422G, 7422G-33, 7422GL:

0.12 l/s (Eco)  
200 kPa (0.2 l/s)

max. +65°C

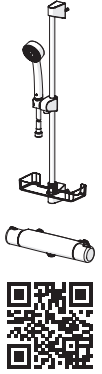
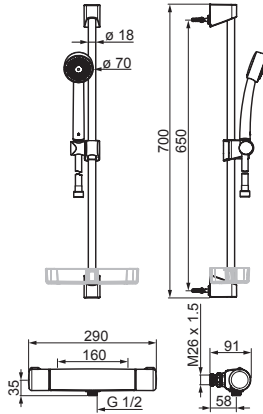

[mpi.oras.com/7422](http://mpi.oras.com/7422)

## 7424 (7466+520)

I (ISO 3822) Oras lab.  
EN 1111, EN 1112, EN 1113  
100 - 1000 kPa

0.19 l/s (Eco)  
0.27 l/s (300 kPa)  
160 kPa (0.2 l/s)

max. +65°C

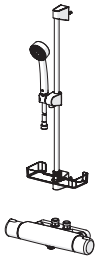
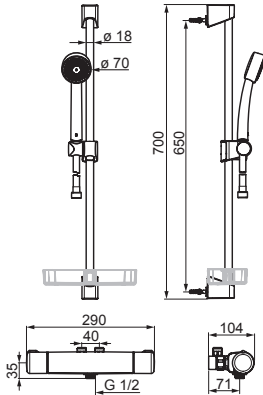

[mpi.oras.com/7424](http://mpi.oras.com/7424)

## 7425 (7460+520), 7425CK

I (ISO 3822) Oras lab.  
EN 1111, EN 1112, EN 1113  
100 - 1000 kPa

### 7425:

0.20 l/s (Eco)  
0.28 l/s (300 kPa)  
155 kPa (0.2 l/s)

### 7425CK:

0.19 l/s (Eco)  
0.27 l/s (300 kPa)  
165 kPa (0.2 l/s)

max. +65°C

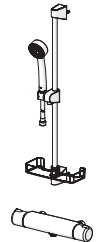
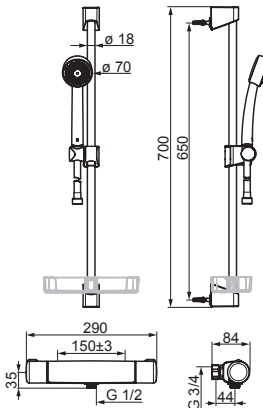

[mpi.oras.com/7425](http://mpi.oras.com/7425)



## 7427 (7464+520)

I (ISO 3822) Oras lab.  
 EN 1111, EN 1112, EN 1113  
 100 - 1000 kPa  
 0.2 l/s (Eco)  
 0.28 l/s (300 kPa)  
 155 kPa (0.2 l/s)

max. +65°C

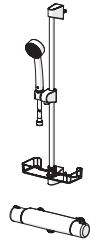
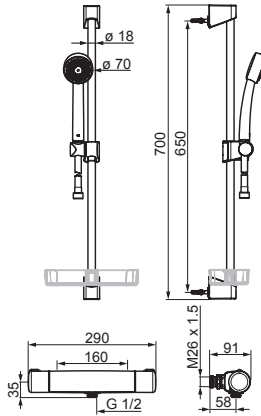

[mpi.oras.com/7427](http://mpi.oras.com/7427)

## 7432 (7466+530), 7432G

I (ISO 3822) Oras lab.  
 EN 1111, EN 1112, EN 1113  
 100 - 1000 kPa  
**7432:**  
 0.12 l/s (300 kPa w/Controller)  
 200 kPa (0.2 l/s)  
**7432G:**  
 0.12 l/s (Eco)  
 200 kPa (0.2 l/s)

max. +65°C

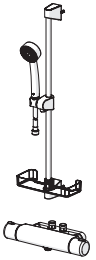
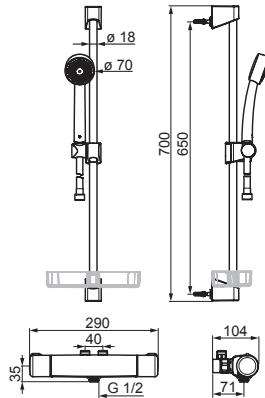

[mpi.oras.com/7432](http://mpi.oras.com/7432)

## 7448 (7462G+261031+520)

I (ISO 3822) Oras lab.  
 EN 1111, EN 1112, EN 1113  
 100 - 1000 kPa  
 0.17 l/s (Eco)  
 0.24 l/s (300 kPa)  
 220 kPa (0.2 l/s)

max. +65°C

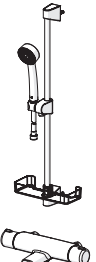
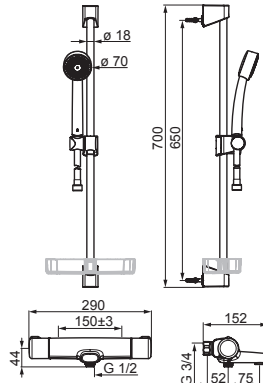

[mpi.oras.com/7448](http://mpi.oras.com/7448)

## 7452U (7460U+530)

I (ISO 3822) Oras lab.  
 EN 1111, EN 1112, EN 1113  
 100 - 1000 kPa  
 0.12 l/s (300 kPa w/Controller)

max. +65°C

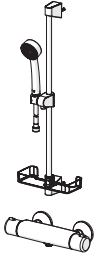
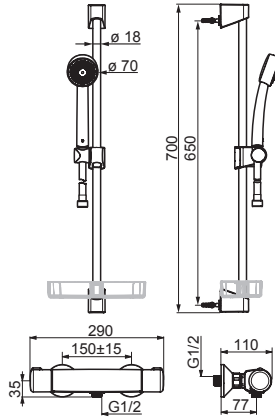

[mpi.oras.com/7452U](http://mpi.oras.com/7452U)

## 7453 (7462G+544)

I (ISO 3822) Oras lab.  
 EN 1111, EN 1112, EN 1113  
 100 - 1000 kPa  
 0.17 l/s (Eco)  
 0.26 l/s (300 kPa)  
 200 kPa (0.2 l/s)

max. +65°C

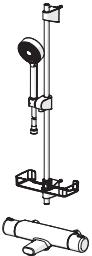
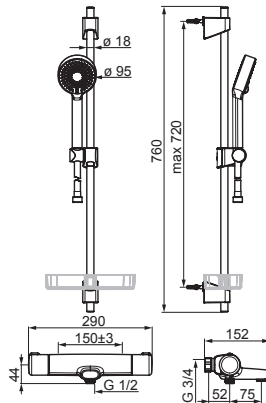

[mpi.oras.com/7453](http://mpi.oras.com/7453)

## 7455 (7461+261033+544)

I (ISO 3822) Oras lab.  
 EN 1111, EN 1112, EN 1113  
 100 - 1000 kPa  
 0.2 l/s (Eco)  
 0.28 l/s (300 kPa)  
 160 kPa (0.2 l/s)

max. +65°C

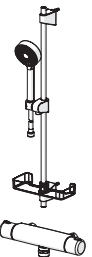
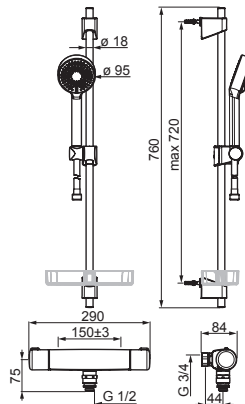

[mpi.oras.com/7455](http://mpi.oras.com/7455)



## 7495 (7461+261033+520)

I (ISO 3822) Oras lab.  
EN 1111, EN 1112, EN 1113  
100 - 1000 kPa  
0.2 l/s (Eco)  
0.28 l/s (300 kPa)  
155 kPa (0.2 l/s)

max. +65°C

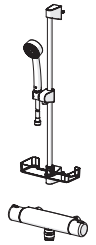
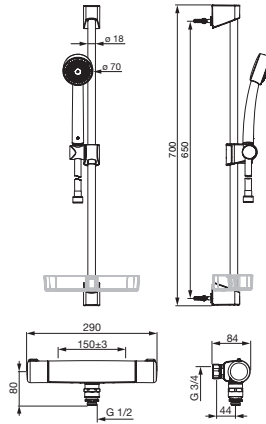

[mpi.oras.com/7495](http://mpi.oras.com/7495)

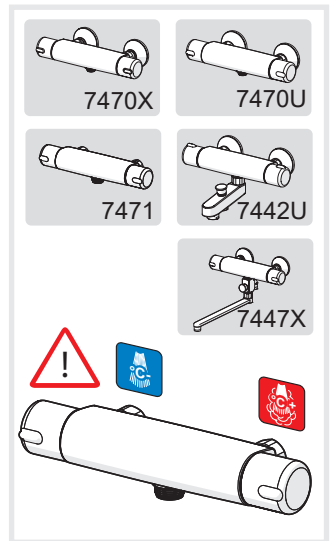
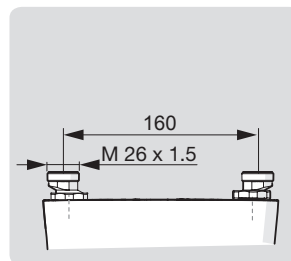
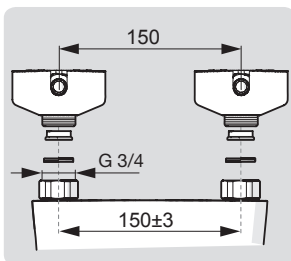
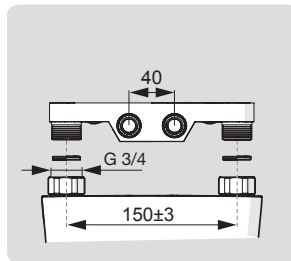
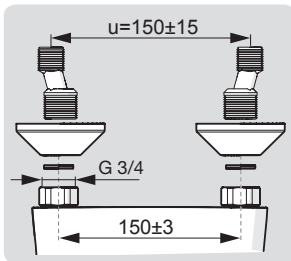
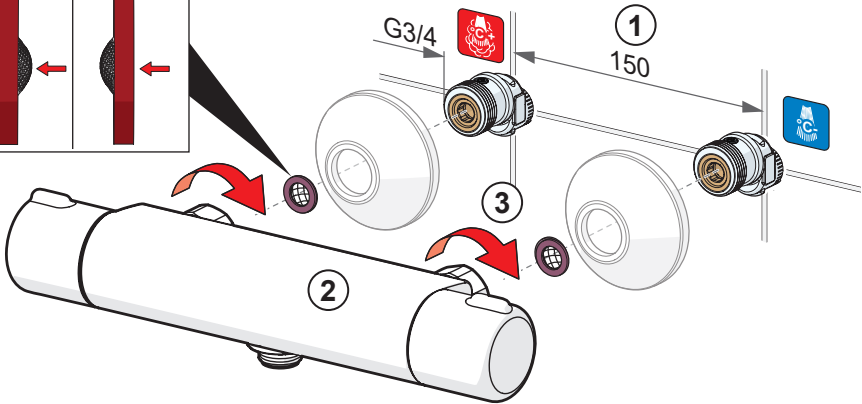
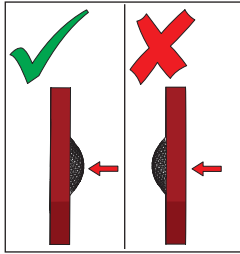
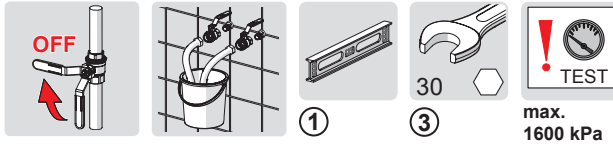

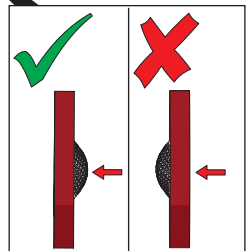
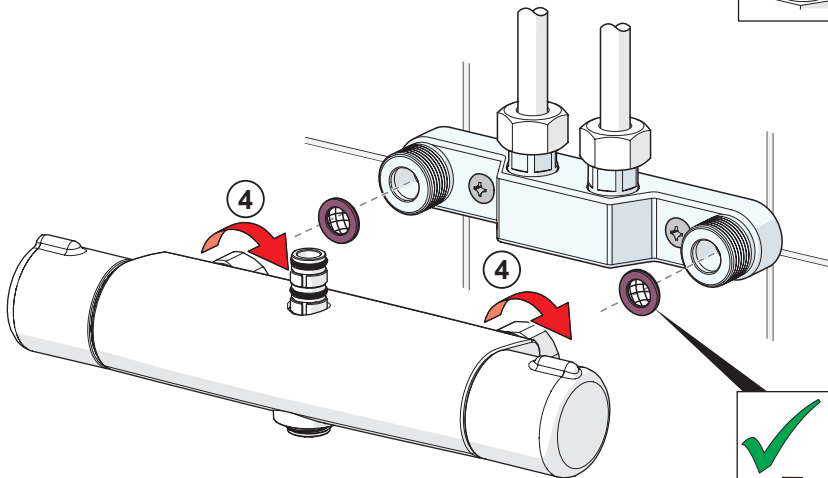
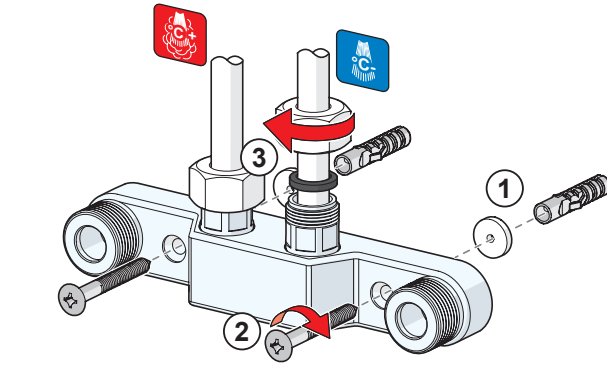
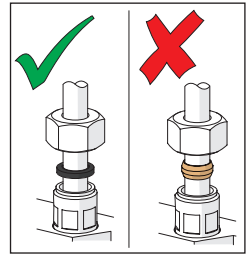
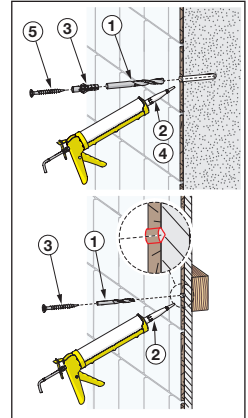
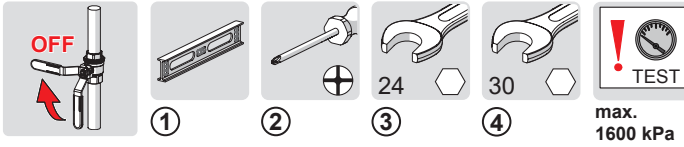

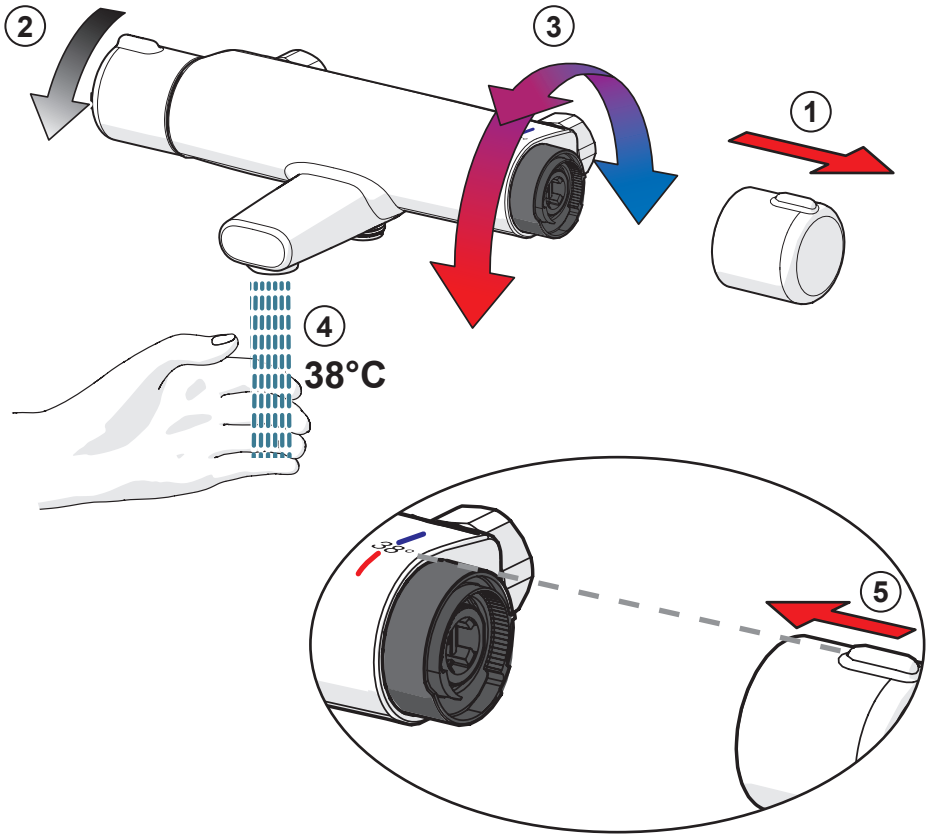

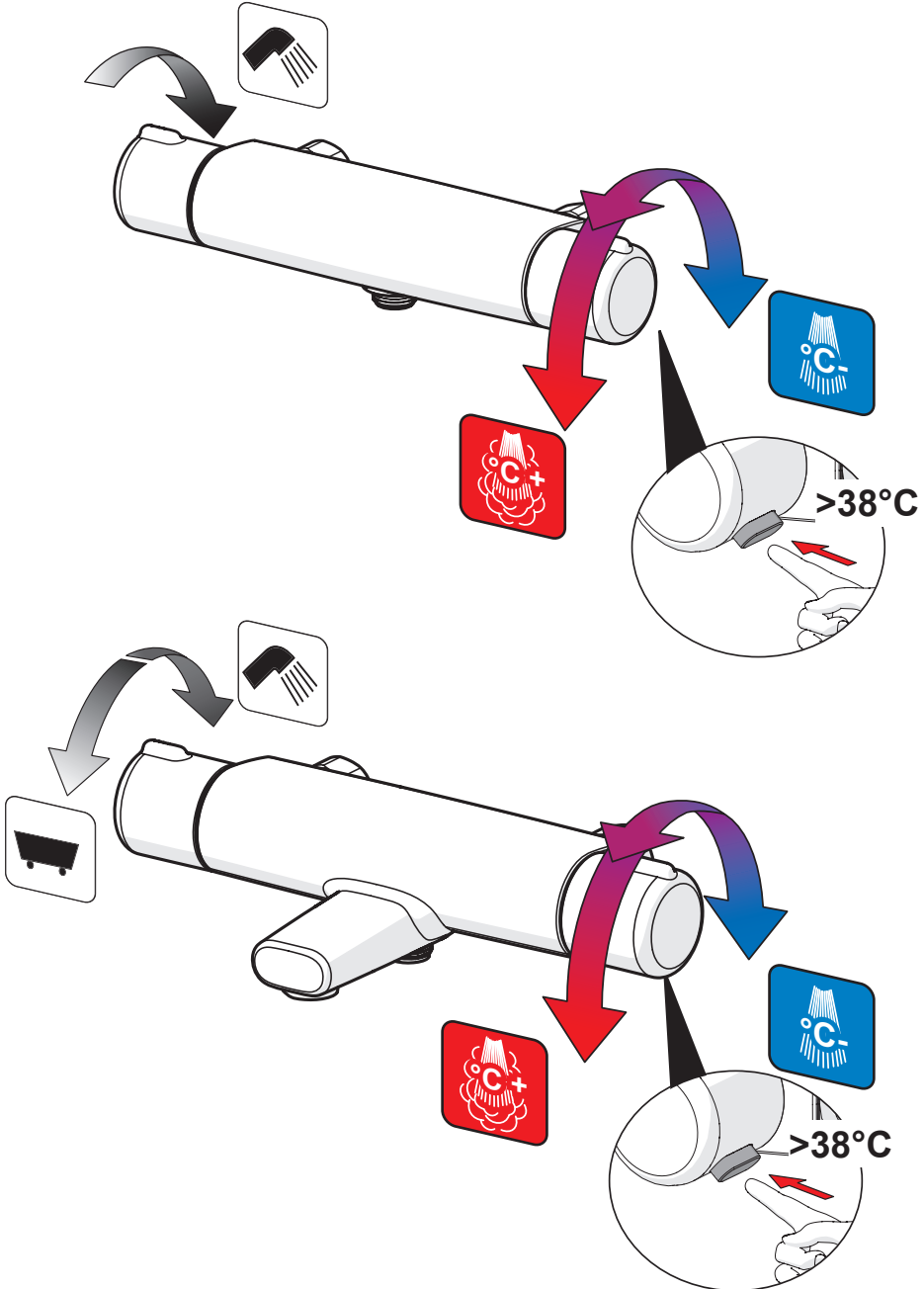



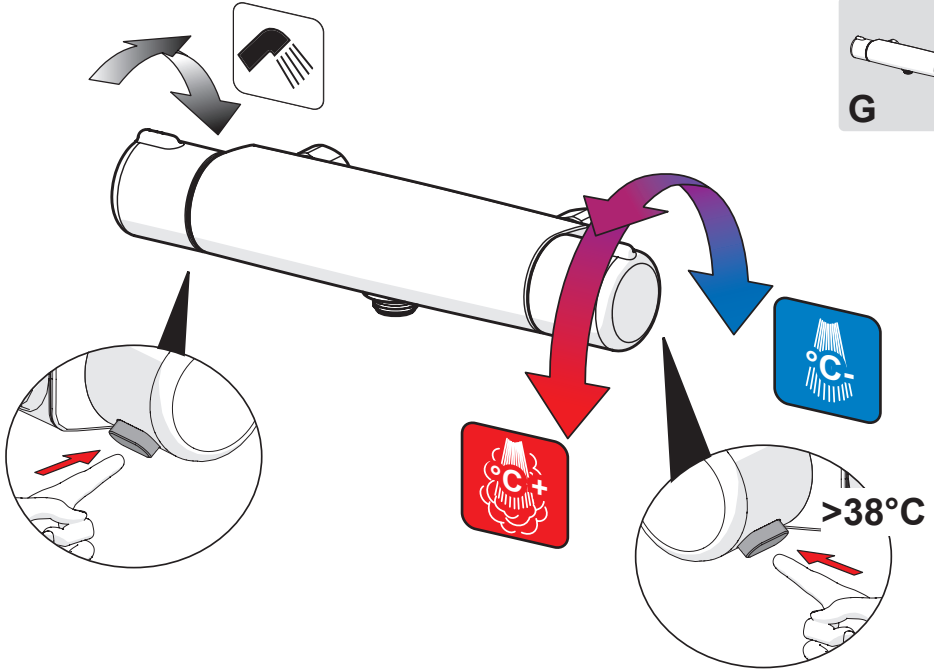

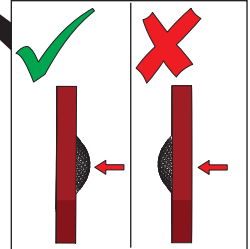
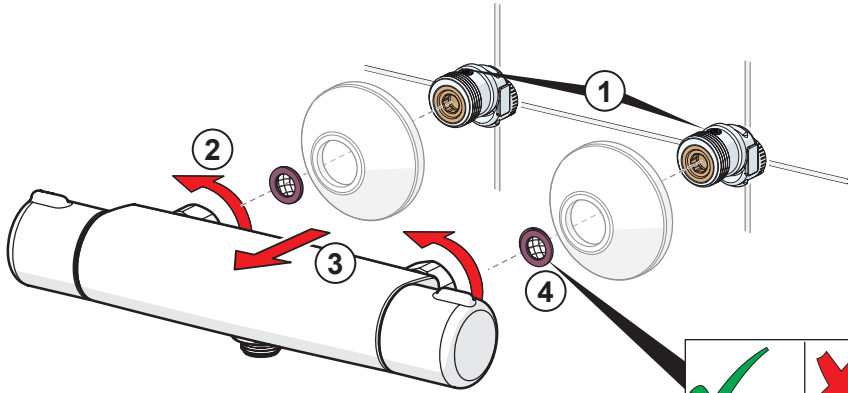
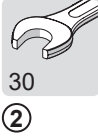
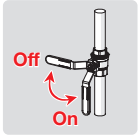
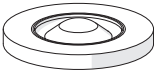

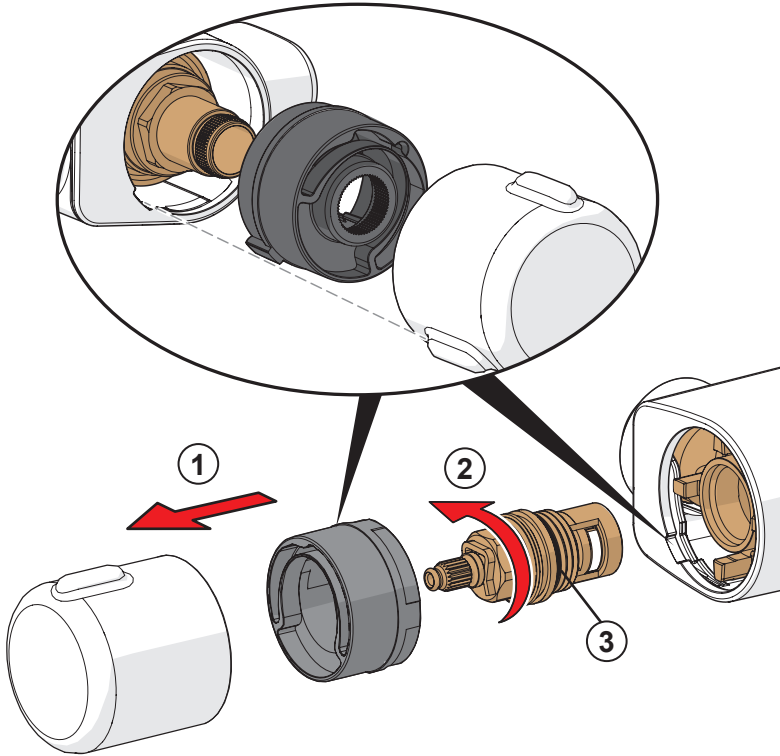
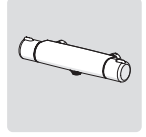
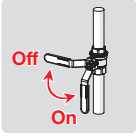

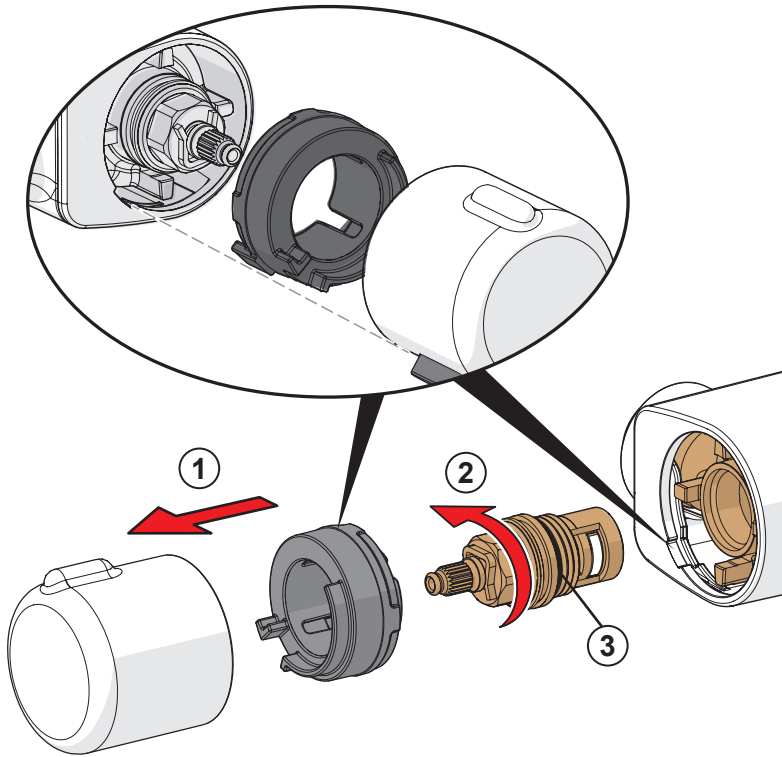
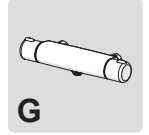

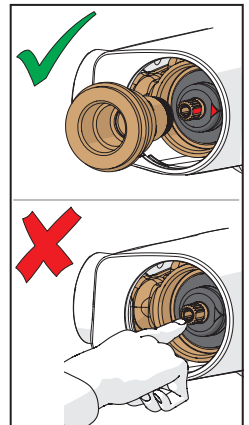
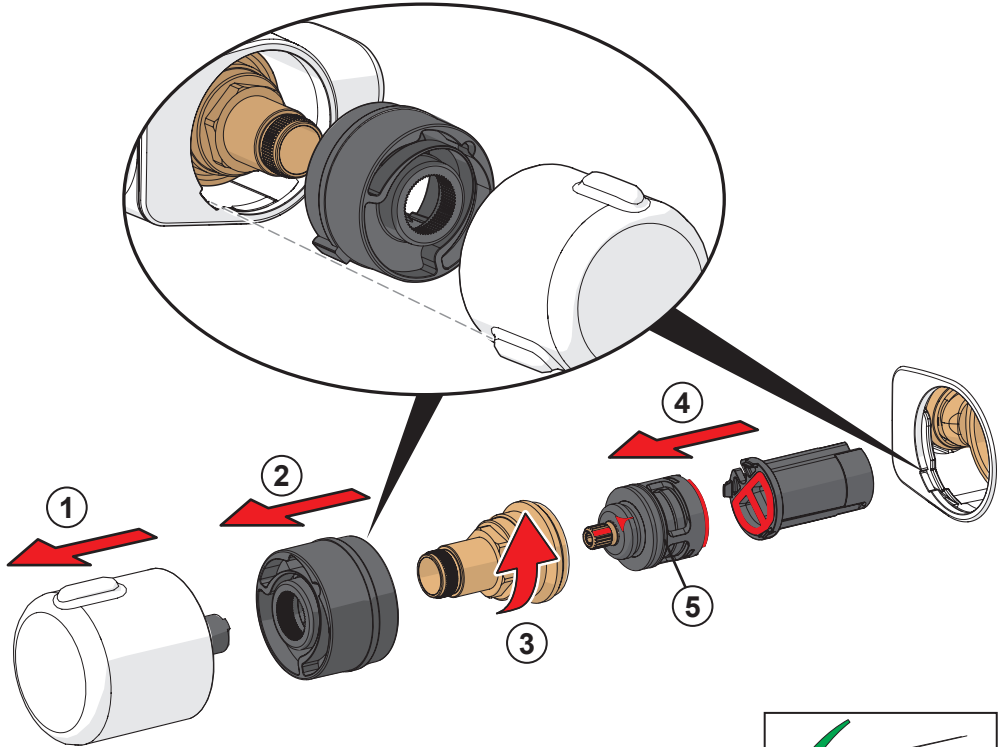
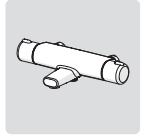
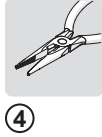
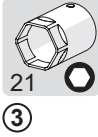
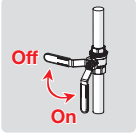
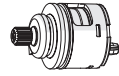

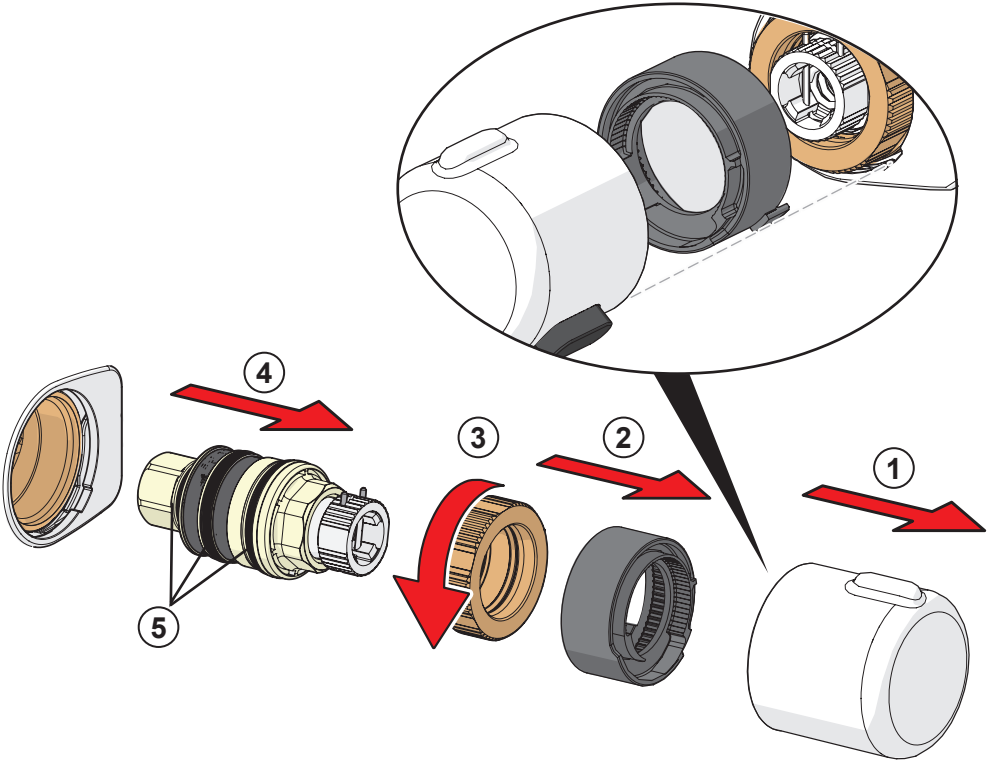
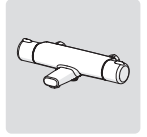
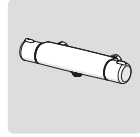
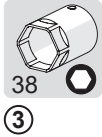

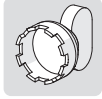

①



②

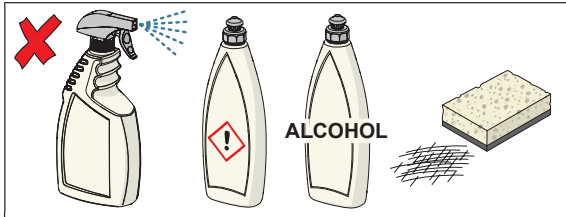
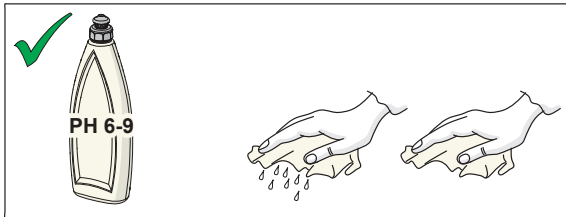
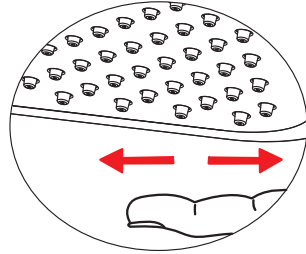
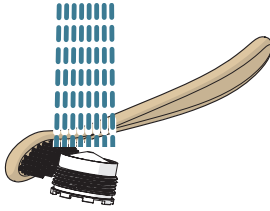

[cleaning.oras.com](http://cleaning.oras.com)











#### About Oras Group

Oras Group is a significant European provider of sanitary fittings: the market leader in the Nordics and a leading company in Continental Europe.

The company's mission is to create the smartest water experiences for everyone and its vision is to become the Perfect Flow Company.

The Group has two strong brands, Oras and Hansa. Oras Group is owned by Oras Invest, a family company, and an industrial owner.

The domicile of Oras Ltd, the parent company of the Group, is located in Rauma, Finland, and the Group has three manufacturing sites: Kralovice (Czech Republic), Olesno (Poland) and Rauma (Finland).

The Group operates with its own staff in 17 markets. Oras Group's net sales were 233.5 million euros in 2021 and at the end of the period the company employed 1255 people.

ORAS Ltd  
Isometsäntie 2, P.O. Box 40  
FI-26101 Rauma  
Tel. +358 2 83 161  
Fax +358 2 831 6300  
info.finland@oras.com  
www.oras.com



943213-04-24